



User manual

NNB 21

Line-impedance Stabilization Network



Copyright (C) Dipl.- Ing. David Walde
Langer EMV-Technik GmbH
2009

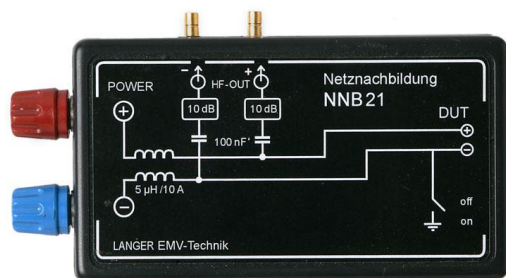

Measurement of conducted disturbance emissions in board networks

Table of contents

1. Measuring method	2
2. Response	3
3. Impedance characteristic	4
4. Safety precautions.....	5
5. Warranty.....	7
6. Technical specifications.....	7
7. Scope of delivery:	7

1. Measuring method

The line-impedance stabilization network has been designed for measuring conducted disturbance emissions in board networks and general applications. Measurements can be performed in the frequency range from 100 kHz to 200 MHz according to the standard CISPR 25/ISO 7637. The range has been extended to 1 GHz for measurements in the course of development.

The measurement set-up should be as follows:

- Place the DUT and line-impedance stabilization network on a ground plane,
- Install the NNB21 in the supply line between the DUT and power source,
- Lay the cables between the DUT and NNB21 as short and flat as possible above the ground plane,
 - for frequencies up to 200 MHz less than 30 cm,
 - for measurements with an upper limit frequency of 1 GHz less than 5 cm,
- Connect the negative measuring channel to ground via the ground switch for measurements on the positive line (there is only a small interaction between the ground switch and the positive line)
- Open the ground switch according to the drawing for measurements on the negative measuring channel.

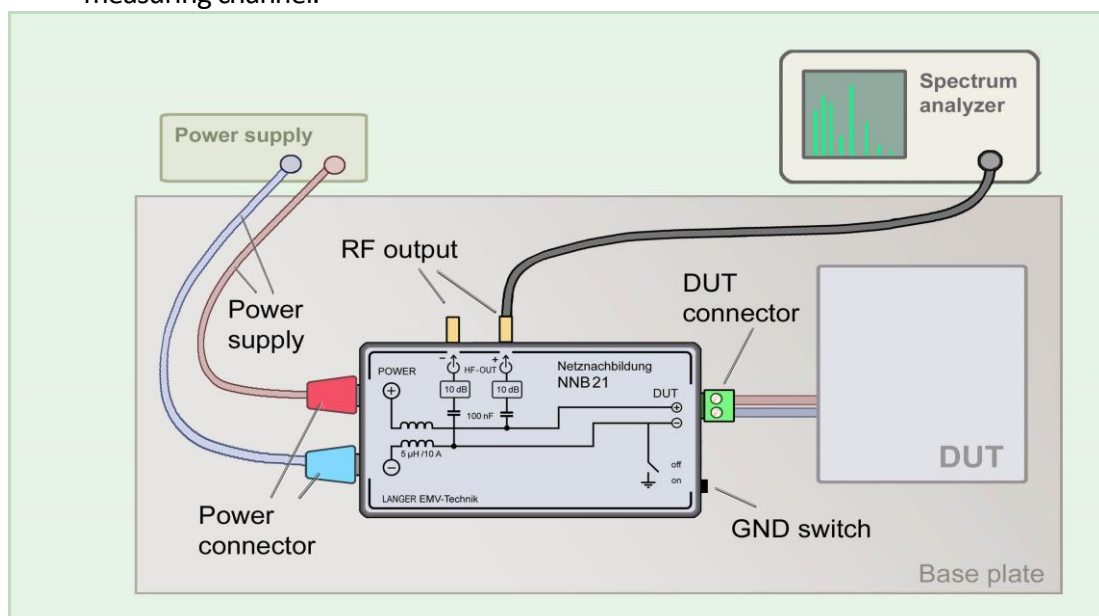

2. Response

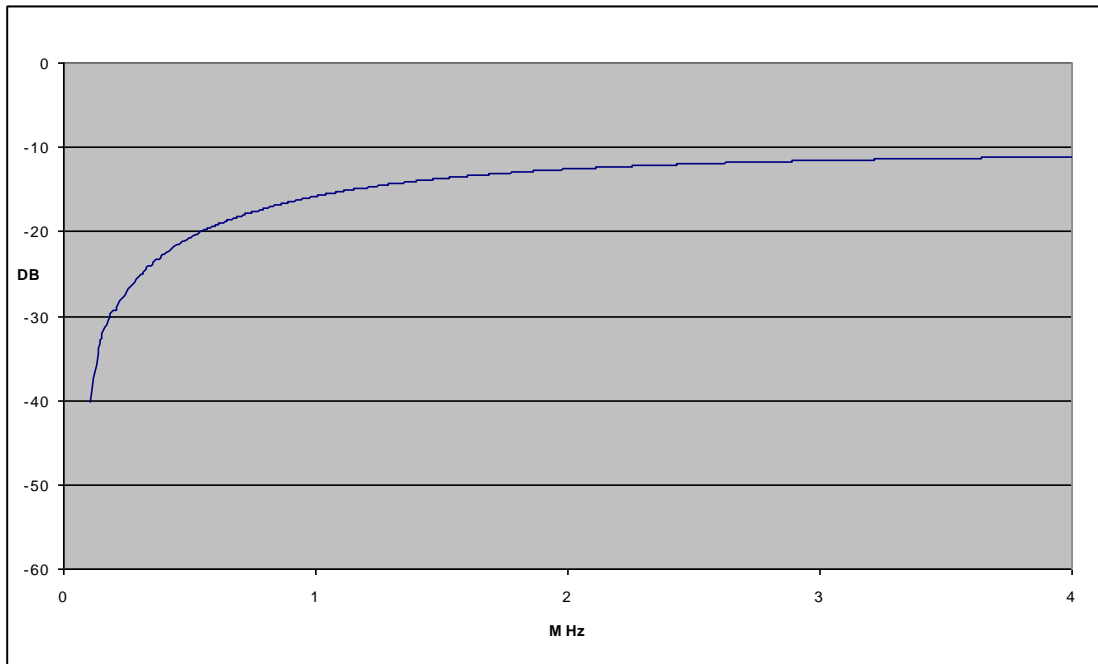

Response of the DUT terminals (outgoing to the DUT) to the RF output line if a constant RF voltage is supplied to the DUT terminals – lower frequency range, rising characteristic

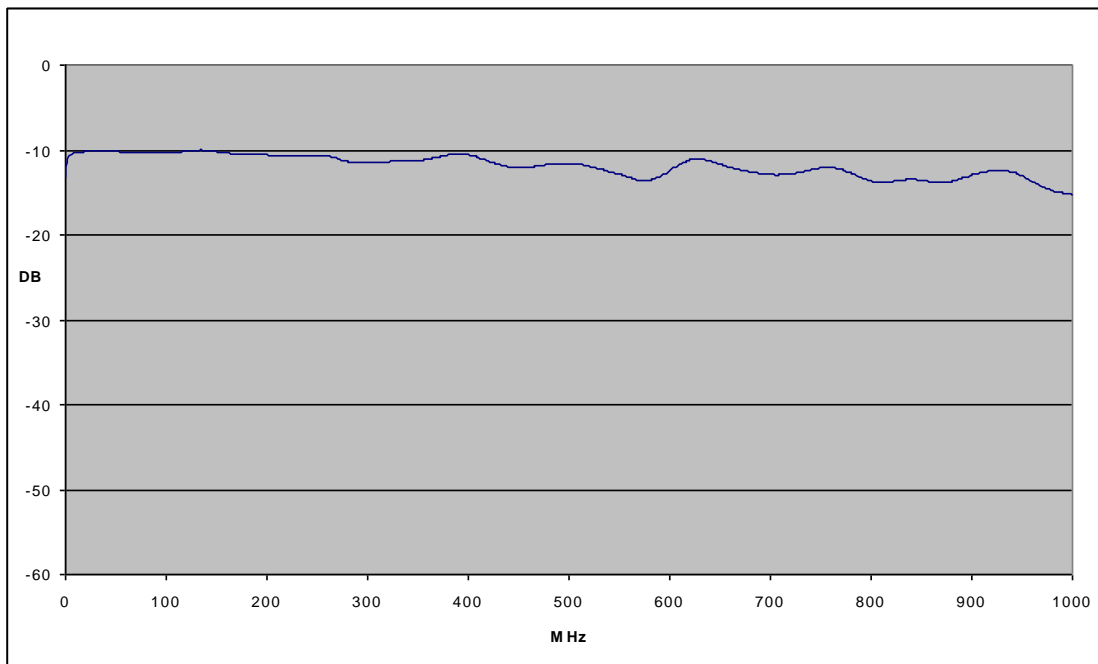

Response of the DUT terminals to the RF output line (outgoing to the DUT) if a constant RF voltage is supplied to the DUT terminals – total frequency range, constant characteristic, drop in the upper frequency range

3. Impedance characteristic

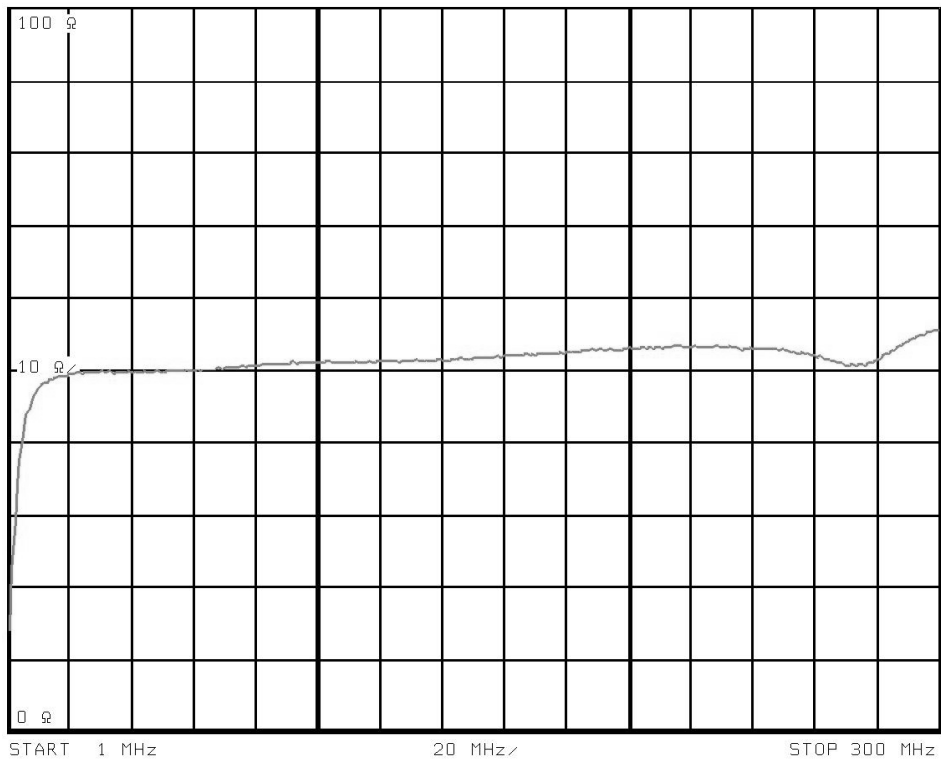

Impedance on the positive measuring line (outgoing to the DUT) if the positive RF measuring channel is terminated by 50 Ω

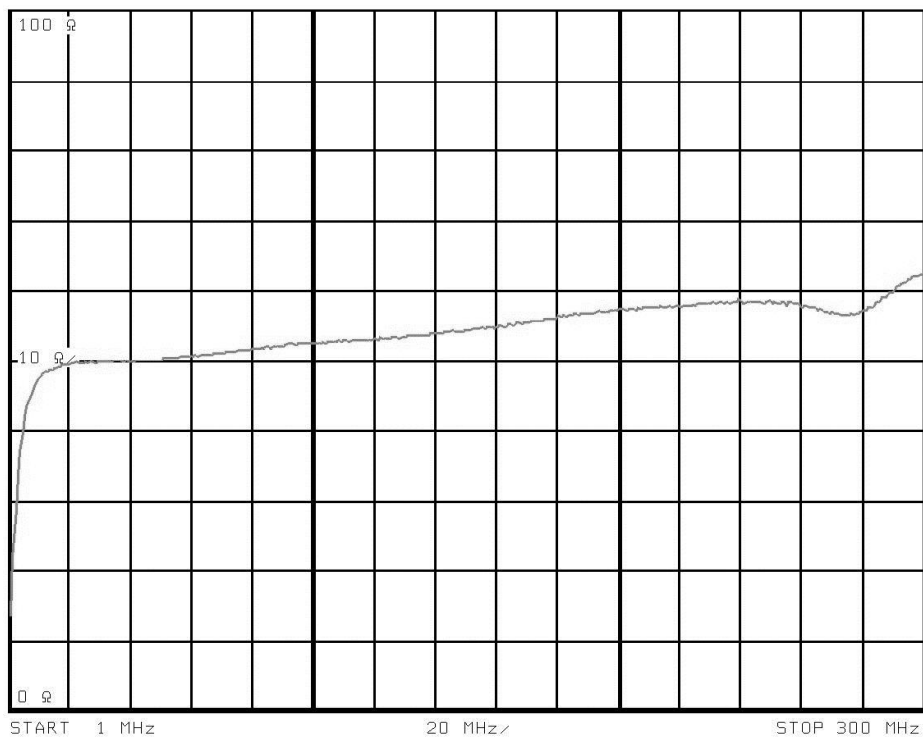

Impedance on the negative measuring line (outgoing to the DUT) if the negative RF measuring channel is terminated by 50 Ω (ground switch is open)

4. Safety precautions

When using a product from LANGER EMV Technik, please observe the following safety instructions to protect yourself from electric shock or the risk of injuries:

- Read and follow the operating instructions.
- Keep the operating instructions in a safe place for later use.
- Observe the safety instructions and warnings provided on the product.
- Visually inspect the product from LANGER EMV-Technik GmbH before using it.
- The product from LANGER EMV-Technik GmbH may only be used for its intended purposes. Any other use is prohibited.

Basic safety instructions

1.

The product may only be operated in the operating states described by the manufacturer. Unless otherwise specified in the data sheet: the products are solely for indoor use. A maximum rated voltage tolerance of $\pm 10\%$ and rated frequency tolerance of $\pm 5\%$ is permissible for the power supply.

2.

The local and national safety and accident prevention regulations have to be observed when working on and with the product. The product may only be opened by authorized specialist personnel. The product has to be isolated from the supply mains before any work is performed on the product or this is opened. Only authorized electrical specialists may change any parts and carry out balancing adjustments as well as maintenance or repair work. Only original parts may be used if safety-relevant parts (such as mains switches, mains transformers or fuses) have to be replaced. A safety test has to be performed each time a safety-relevant part has been replaced.

3.

Hazardous substances may be released if products / components are subjected to mechanical and/or thermal treatment beyond their intended use. The product may thus only be dismantled, for example during its disposal, by qualified specialist personnel or Langer EMV-Technik GmbH. Improper dismantling may be harmful. All national regulations pertaining to the disposal must be observed.

4.

Higher functional electromagnetic radiation and near fields occur when the product is operated. In consideration of the fact that unborn children deserve particular protection, pregnant women should be protected by appropriate measures. Furthermore, persons with a pace-maker may be at risk through electromagnetic radiation. Interference with electronic products outside the EMC environment on site should be prevented by observing the respective safe distances or using shielded rooms. The employer is responsible for assessing work places which are exposed to a special risk of radiation and eliminate hazards if necessary.

5.
Parts or materials may only be added to or removed from a product from Langer EMV-Technik GmbH if this is switched off.

6.
The employer is responsible for choosing the appropriate personnel for operating the products.

7.
Only use the product with the specified type of battery. Make sure before commissioning that the batteries show no signs of damage and are fully charged on fitting.

8.
Never remove a part of the housing whilst the product is in operation. This exposes electrical lines and components and may lead to personal injuries, fire and damage to the product.

9.
Never insert any objects in the openings of the housing which are not intended for this purpose. Never pour any liquids over or into the housing. This may cause short-circuits in the product and/or electric shock, fire or personal injuries.

10.
Never use the product under conditions which may or did lead to condensation in or on the product, for example, after the product was moved from a cold to a warm environment.

11.
Only use neutral detergents for cleaning the product. Never use alcohol, petrol or solvents.

We will remedy each defect which is due to defective materials or defective manufacture, either by repair or supply of spare parts, during the legal warranty period. The warranty period is subject to the applicable law of the country where the product from Langer EMV-Technik GmbH was purchased.

5. Warranty

Langer EMV-Technik GmbH will remedy any fault due to defective material or defective manufacture, either by repair or by delivery of replacement, during the statutory warranty period.

This warranty is only granted on condition that:

- the information and instructions in the user manual have been observed.

The warranty will be forfeited if:

- an unauthorized repair is performed on the product,
- the product is modified,
- the product is not used according to its intended purpose.

6. Technical specifications

RF path

Measuring channels: 2, one path can be deactivated

Frequency range: 100 kHz – 1 GHz

Internal damping: 10 dB

Board networks path

Max. continuous current: 10 A

Max. operating voltage: 50 V

DC resistance: < 20 mΩ

7. Scope of delivery:

- 1x NNB 21
- 1x RF cable SMB-BNC
- 4x 2-pole clamp terminals
- User manual
- Case insert / Quick guide
- Case with foam insert



 北京海洋兴业科技股份有限公司

北京市西三旗东黄平路 19 号龙旗广场 4 号楼(E座)906 室

电 话: 010-62176775 62178811 62176785

企业 QQ: 800057747

企业官网: www.hyxyyq.com

邮编: 100096

传真: 010-62176619

邮箱: info.oi@oitek.com.cn

购线网: www.gooxian.net



扫描二维码关注我们
查找微信企业号: 海洋仪器