



Instructions



P3010
100 MHz 10X Passive Probe
With Readout

071-0466-00



General Safety Summary

Review the following safety precautions to avoid injury and prevent damage to this product or any products connected to it. To avoid potential hazards, use this product only as specified.

To Avoid Fire or Personal Injury

Observe Maximum Working Voltage. Do not use the P3010 probe above 300 V_{RMS}, CAT II. Refer to the derating chart, Figure 2, on page 12.

Connect and Disconnect Properly. Connect the probe output to the measurement instrument before connecting the probe to the circuit under test. Disconnect the probe input and the probe ground from the circuit under test before disconnecting the probe from the measurement instrument.

Do Not Elevate the Common Terminal. The common terminal is at ground potential. Do not connect the common terminal to elevated voltages.

Do Not Operate With Suspected Failures. If you suspect there is damage to this product, have it inspected by qualified service personnel.

Do Not Operate in Wet/Damp Conditions.

Do Not Operate in an Explosive Atmosphere.

Keep Product Surfaces Clean and Dry.

Safety Terms and Symbols

Terms in This Manual. These terms may appear in this manual:



WARNING. *Warning statements identify conditions or practices that could result in injury or loss of life.*



CAUTION. *Caution statements identify conditions or practices that could result in damage to this product or other property.*

Features and Accessories

The P3010 probe is compatible with TDS3000 series 100 MHz oscilloscopes. The probe is also compatible with Tektronix oscilloscopes that automatically detect probe attenuation and adjust the scale readout accordingly.

NOTE Remove and discard the protective cover on the tip of the probe before attempting to connect a probe tip accessory.

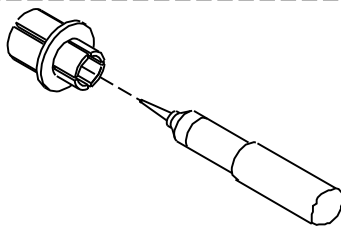

BNC-to-probe tip adapter. To install the adapter, push the wide end firmly into a BNC connector. Then insert the probe tip firmly into the adapter.

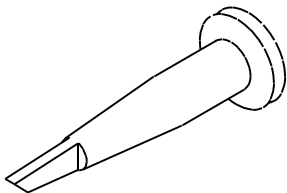

Retractable hook tip. Use the retractable hook tip to make hands-free measurements.

NOTE. For a solid connection, firmly push and twist the hook tip onto the probe tip before using.

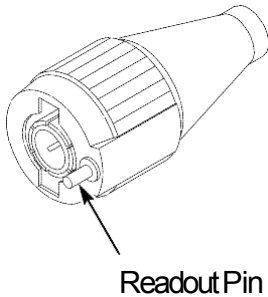

Readout pin. The P3010 is compatible with Tektronix oscilloscopes that automatically detect and display the attenuation factor of the probe.

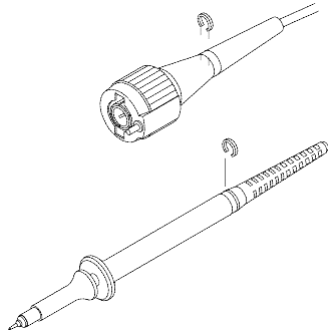

Marker rings. Attach the matching colored rings onto the probe cable and tip as shown.

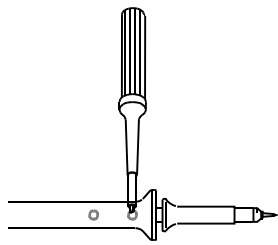

Adjustment tool. Use the adjustment tool for probe compensation adjustments.

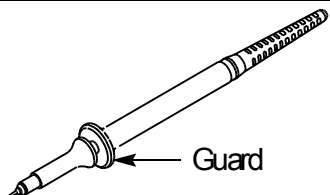

Guard. The guard provides a finger barrier for protection from electric shock.



WARNING. To avoid electric shock when using the probe, keep fingers behind the guard on the probe body.

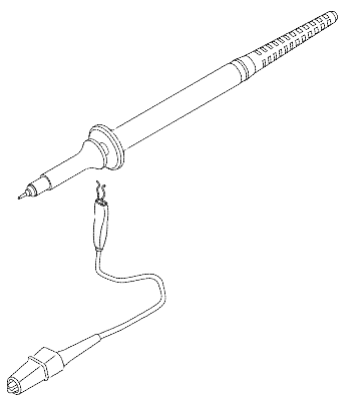

GroundLead. Use the alligator clip to attach the probe to a ground reference.

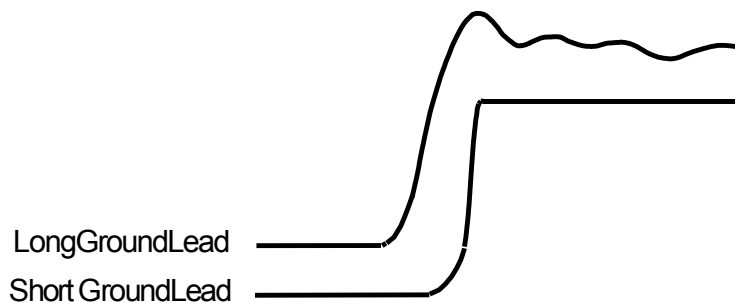

To see the best signal, use the shortest possible ground lead and signal path.

Maintenance

This section describes how to maintain the probe.

Low-Frequency Probe Compensation

Before taking any measurements using a probe, first check the compensation of the probe and adjust it to match the channel inputs.

Most oscilloscopes have a square wave reference signal available at a terminal on the front panel used to compensate the probe.

1. Connect the probe to the signal source to display a 1 kHz test signal on your oscilloscope.
2. Adjust the LF trimmer on the probe so that the corners of the square wave are square and the top is flat.

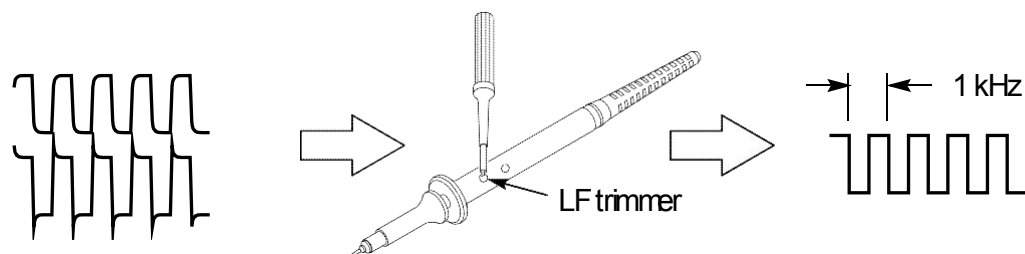

High-Frequency Probe Compensation

The probe high-frequency compensation should seldom require adjustment; however, your probe may require high-frequency adjustment if any of the following are true:

- the probe has high-frequency aberrations
- the probe does not perform at the rated bandwidth
- you have installed the probe on an oscilloscope having an input capacitance near the limits of the probe compensation range (See Table 1.)

To perform the high-frequency compensation adjustment you will need a signal source that has all of the following characteristics:

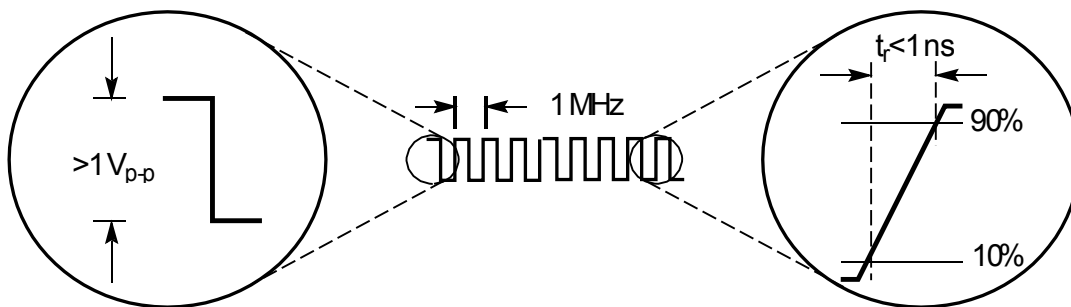

- square-wave output at 1 MHz
- fast rise output with rise time less than 1 ns
- output properly terminated

1. Connect the probe to the signal source to display a 1 MHz test signal on your oscilloscope. The display should be similar to that shown in Figure 1(a).
2. Adjust the HF trimmer until the waveform is flat on top and has a square leading edge.

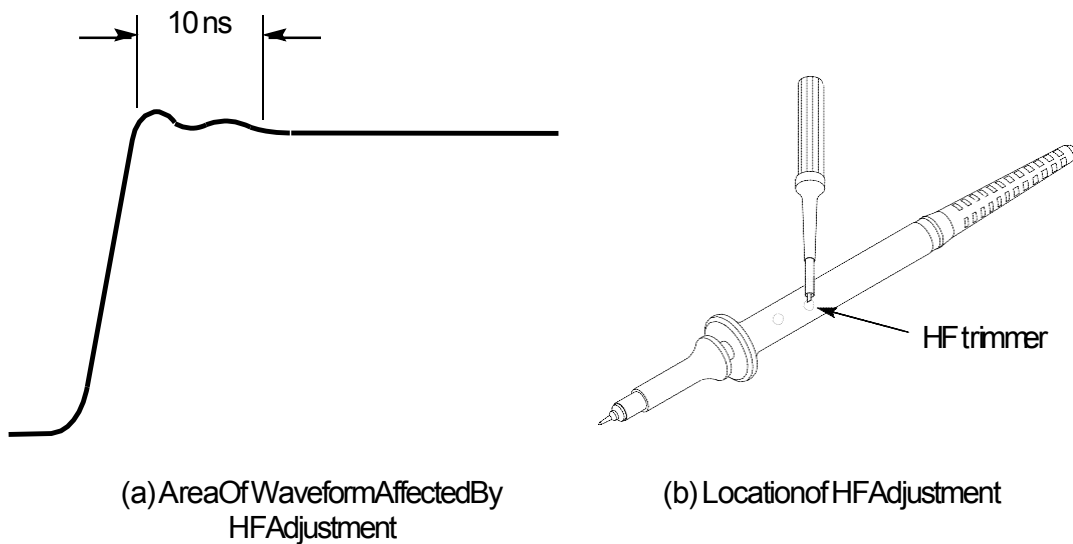

Figure1: HFCompensation

Cleaning

To prevent damage to probe materials, avoid using chemicals that contain benzine, benzene, toluene, xylene, acetone, or similar solvents.

Do not immerse the probe or use abrasive cleaners.

Dirt may be removed with a soft cloth dampened with a mild detergent and water solution, or isopropyl alcohol.

Replacing Probe Parts

Other than accessories, only the probe tip is replaceable.

Replacement probe tips are available as optional accessories. Refer to the replaceable parts list at the end of this manual for more information.

To remove a tip assembly, firmly grasp the pointed tip with pliers and withdraw the assembly from the barrel.

No tools are required to install a replacement tip. Insert a new probe tip into the probe barrel as far as possible using finger pressure. If necessary, seat the plastic portion of the tip against the probe barrel by pressing the tip gently but firmly against a hard surface, such as a wood block or table top.

Specifications

These characteristics apply to a P3010 probe installed on a Tektronix TDS3000 series 100 MHz oscilloscope.

The instrument must have a warm-up period of at least 20 minutes and be in an environment that does not exceed the limits described in Table 2.

Table 1: Electrical Characteristics

Attenuation (system)	10X \pm 2.5% at
DC Input Resistance(system), typical	10M Ω
Input Capacitance, typical	13.3pF
Compensation Range, typical	10pF to 15pF
System Bandwidth (-3dB)	DC to 100MHz
Maximum Working Input Voltage	300V _{RMS} , CAT I & II (500V peak, duty factor < 35%, pulsewidth < 100msec) 150V _{RMS} , CAT III (250V peak, duty factor < 35%, pulsewidth < 100msec) See derating information in Figure 2 on page 12
Rise time (system), typical	3.5 ns
Input impedance and phase, typical	See Figure 3 on page 13

Specifications

Table 2: Physical and Environmental Characteristics

Net Weight (including accessories)	320g
Cable Length	2 meters
Temperature Range ¹	
Operating	-15° C to +55° C
Nonoperating	-62° C to +85° C
Humidity ¹	95% to 97% Relative Humidity (30°C to 55°C)
Altitude	
Operating	< 3000 meters
Nonoperating	< 15240 meters

¹ Tektronix Standard 062-2847-00, class 3. Refer to MIL-T-28800E for class 3 equipment.

Table3: Certifications and compliances

EC Declaration of Conformity – Low Voltage	<p>Compliance was demonstrated to the following specifications listed in the Official Journal of the European Communities:</p> <p>Low Voltage Directive 73/23/EEC, as amended by 93/68/EEC: EN61010-1/A2:1995 Safety requirements for electrical equipment for measurement, control, and laboratory use EN61010-2-031:1994 Particular requirements for hand-held probe assemblies for electrical measurement and test equipment</p>
Approvals	<p>UL3111-1 – Standard for electrical measuring and test equipment</p> <p>IEC61010-2-031 – Particular requirements for hand-held probe assemblies for electrical measurement and test</p> <p>CAN/CSA-C22.2 No. 1010.1-92 and CAN/CSA-C22.2 No. 1010.2.031-94 – Safety requirements for electrical equipment for measurement, control, and laboratory use</p>
Installation Category Descriptions	<p>Terminals on this product may have different installation category designations. The installation categories are:</p> <p>CAT III Distribution-level mains (usually permanently connected). Equipment at this level is typically in a fixed industrial location</p> <p>CAT II Local-level mains (wall sockets). Equipment at this level includes appliances, portable tools, and similar products. Equipment is usually cord-connected</p> <p>CAT I Secondary (signal level) or battery operated circuits of electronic equipment</p>
Pollution Degree 2	<p>Do not operate in environments where conductive pollutants may be present.</p>

Specifications

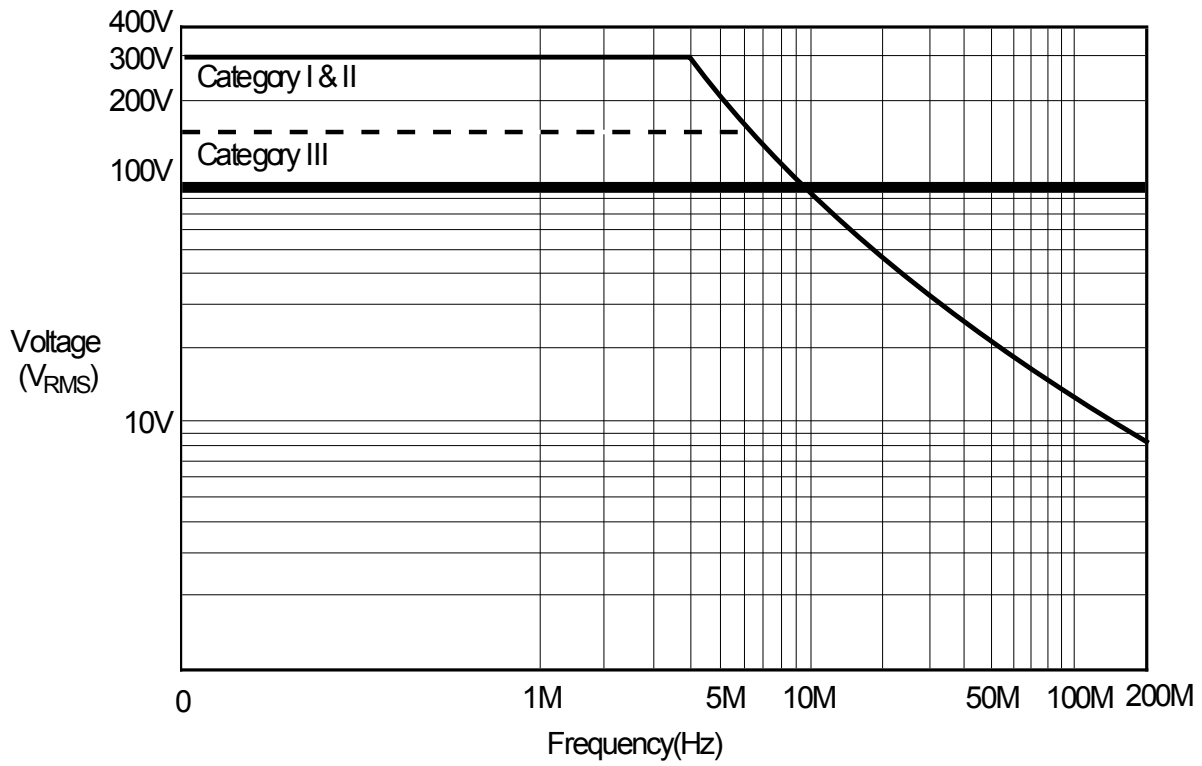

Figure2:MaximumWorkingVoltageDeratingCurve(V_{RMS})

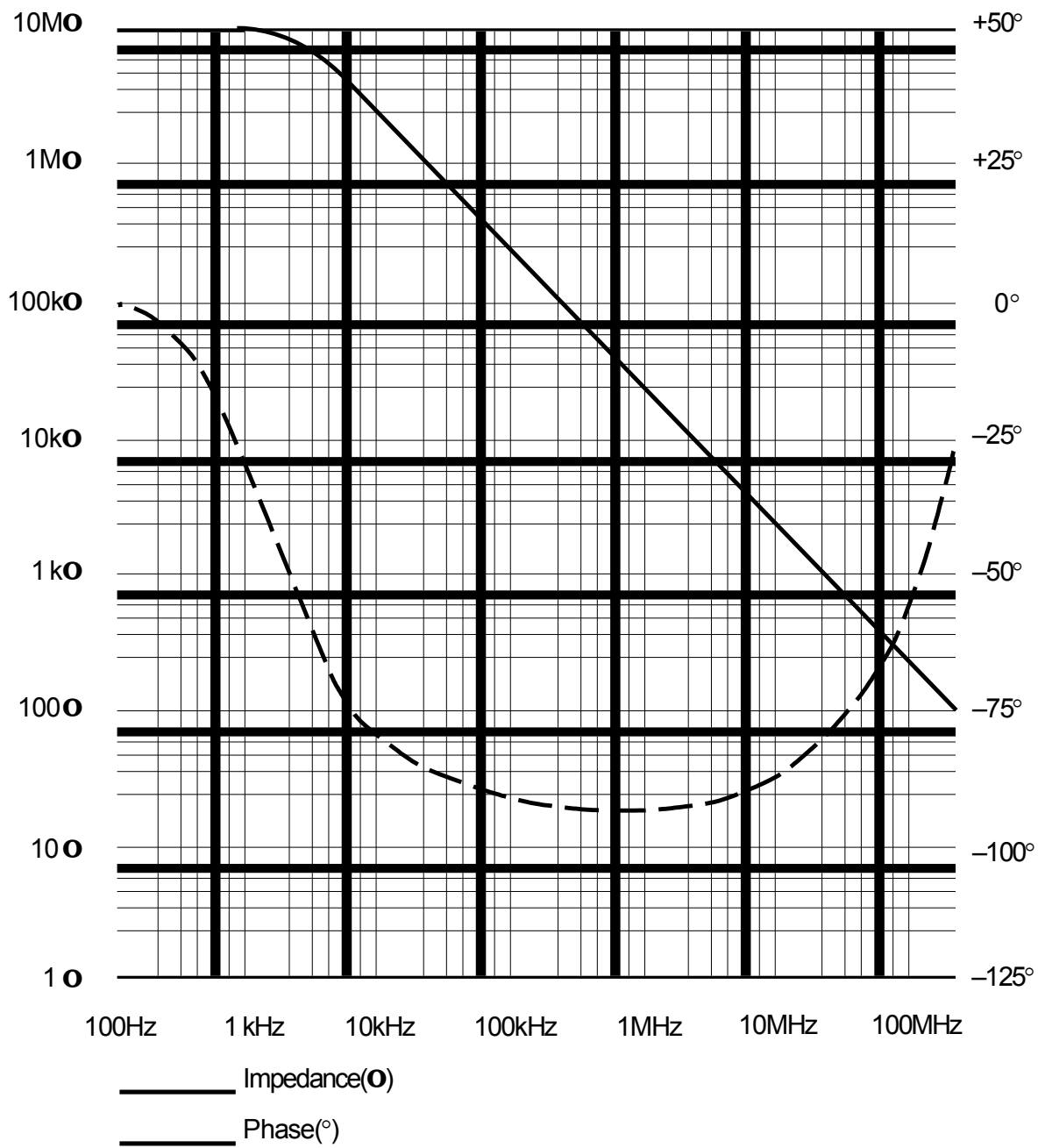
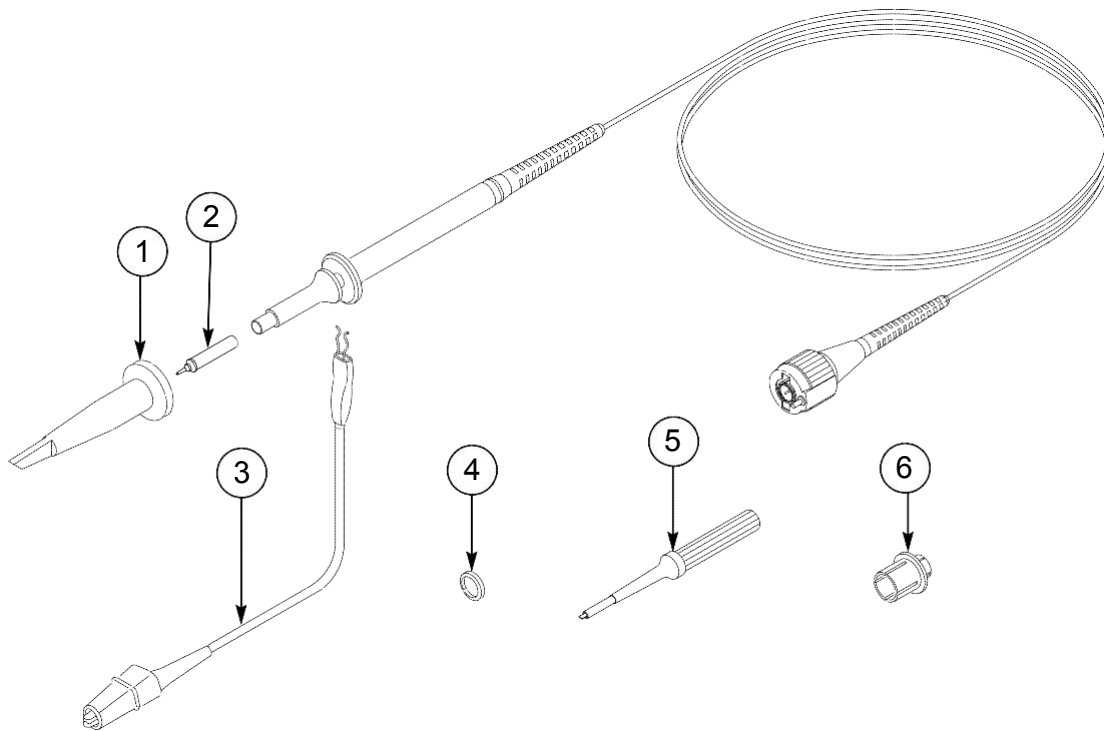
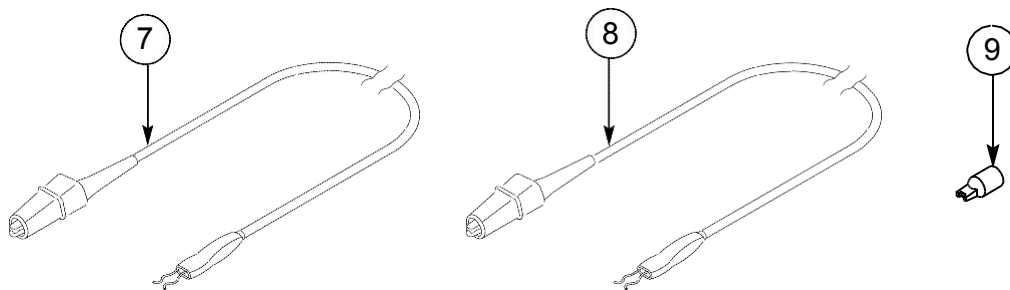

Figure3: Typical input impedance and phase

Replaceable Parts



Standard Accessories



Optional Accessories

Figure4: P3010replaceable parts

Replaceable Parts List

Fig.& index number	Tektronix part number	Serial no. effective	Serial no. discont'd	Qty	Name & description	Mfr. code	Mfr. part number
4-	_____			1	PROBE,PASSIVE:P3010		
					STANDARD ACCESSORIES		
	020-2134-01			1	ACCESSORY KIT:MINIATURE SIZE (Includes items 1, 3, 4, 5, & 6)	80009	020-2134-01
-1	013-0107-08			1	TIP,PROBE:MINIATURE/COMPACT SIZE	TK2565	013-0107-08
-2	See Opt. Acc			1	CONTACT,ELEC:PROBETIPW/INSULATOR ASSY		
-3	196-3120-01			1	LEAD,ELECTRICAL:PROBEGND,6.0L	80009	196-3120-01
-4	016-0633-00			1	MARKER SET,CA:2 EA VARIOUS COLORS	80009	016-0633-00
-5	See Opt. Acc.			1	SCREWDRIVER:ADJUSTMENT TOOL		
-6	013-0277-00			1	ADAPTER,CONN:BNCTO MINIATURE PROBETIP	24931	33A129-1
	071-0466-00			1	MANUAL,TECH:INSTR, P3010, DP	80009	071-0466-00
					OPTIONAL ACCESSORIES		
-2	131-4997-01			1	CONTACT,ELEC:2TIP-INSULATOR W/INFOCARD	80009	131-4997-01
-5	003-1433-01			1	SCREWDRIVER:ADJUSTMENT TOOL, PKG OF 5	80009	003-1433-01
-7	196-3120-21			1	LEAD,ELECTRICAL:PROBEGND,28.0L	80009	196-3120-21
-8	196-3121-01			1	LEAD,ELECTRICAL:PROBEGND,12.0L	80009	196-3121-01
-9	015-0201-07			1	TIP,PROBE:IC TEST, PKG OF 10	80009	015-0201-07

ManufacturersCrossIndex

Mfr. code	Manufacturer	Address	City, state, zip code
24931	BERGELECTRONICSINC	BERGELECTRONICSRF/COAXIALDIV 2100EARLYWOODDR POBOX 547	FRANKLIN, IN46131
80009	TEKTRONIX INC	14150SWKARLBRAUNDR POBOX 500	BEAVERTON, OR97077-0001
TK2565	VISIONPLASTICSINC	26000SWPARKWAYCENTERDRIVE	WILSONVILLE, OR97070

WARRANTY

Tektronix warrants that the products that it manufactures and sells will be free from defects in materials and workmanship for a period of one (1) year from the date of shipment. If a product proves defective during this warranty period, Tektronix, at its option, either will repair the defective product without charge for parts and labor, or will provide a replacement in exchange for the defective product.

In order to obtain service under this warranty, Customer must notify Tektronix of the defect before the expiration of the warranty period and make suitable arrangements for the performance of service. Customer shall be responsible for packaging and shipping the defective product to the service center designated by Tektronix, with shipping charges prepaid. Tektronix shall pay for the return of the product to Customer if the shipment is to a location within the country in which the Tektronix service center is located. Customer shall be responsible for paying all shipping charges, duties, taxes, and any other charges for products returned to any other locations.

This warranty shall not apply to any defect, failure or damage caused by improper use or improper or inadequate maintenance and care. Tektronix shall not be obligated to furnish service under this warranty a) to repair damage resulting from attempts by personnel other than Tektronix representatives to install, repair or service the product; b) to repair damage resulting from improper use or connection to incompatible equipment; c) to repair any damage or malfunction caused by the use of non-Tektronix supplies; or d) to service a product that has been modified or integrated with other products when the effect of such modification or integration increases the time or difficulty of servicing the product.

THIS WARRANTY IS GIVEN BY TEKTRONIX IN LIEU OF ANY OTHER WARRANTIES, EXPRESS OR IMPLIED. TEKTRONIX AND ITS VENDORS DISCLAIM ANY IMPLIED WARRANTIES OF MERCHANTABILITY OR FITNESS FOR A PARTICULAR PURPOSE. TEKTRONIX' RESPONSIBILITY TO REPAIR OR REPLACE DEFECTIVE PRODUCTS IS THE SOLE AND EXCLUSIVE REMEDY PROVIDED TO THE CUSTOMER FOR BREACH OF THIS WARRANTY. TEKTRONIX AND ITS VENDORS WILL NOT BE LIABLE FOR ANY INDIRECT, SPECIAL, INCIDENTAL, OR CONSEQUENTIAL DAMAGES IRRESPECTIVE OF WHETHER TEKTRONIX OR THE VENDOR HAS ADVANCE NOTICE OF THE POSSIBILITY OF SUCH DAMAGES.

北京海洋兴业科技股份有限公司

北京市西三旗东黄平路 19 号龙旗广场 4 号楼(E座)906 室

电 话: 010-62176775 62178811 62176785

企业 QQ: 800057747

企业官网: www.hyxyyq.com

邮编: 100096

传真: 010-62176619

邮箱: info.oi@oitek.com.cn

购线网: www.gooxian.net



扫描二维码关注我们
查找微信企业号: 海洋仪器